



ATTENTION
OBSERVE PRECAUTIONS
FOR HANDLING
ELECTROSTATIC
DISCHARGE
SENSITIVE
DEVICES

ARL-5060URC3 Red (U4F)



Features

- PLCC-6 Package.
- Xtremely wide viewing angle.
- Suitable for all SMT assembly and solder process.
- Available on tape and reel.
- Moisture sensitivity level: Level 4
- Package: 1000pcs/reel.
- RoHS compliant.

Description

- The Red source color devices are made with AlGaInP on Substrate Light Emitting Diode.

Application

- Optical indicator
- Indoor display
- Automotive lighting
- Backlight for LCD, switch and Symbol, display
- Tubular light application
- General use

Package Dimensions

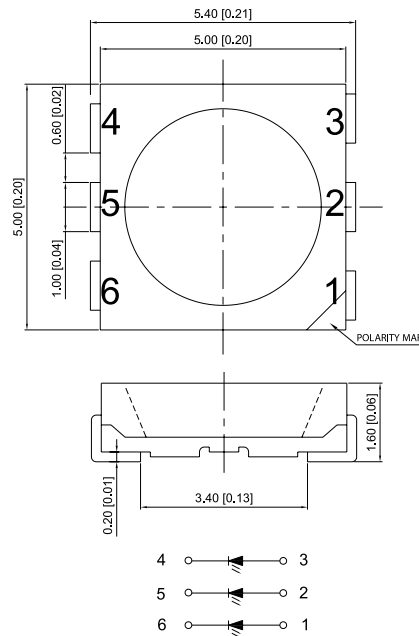

Recommended Soldering Pattern

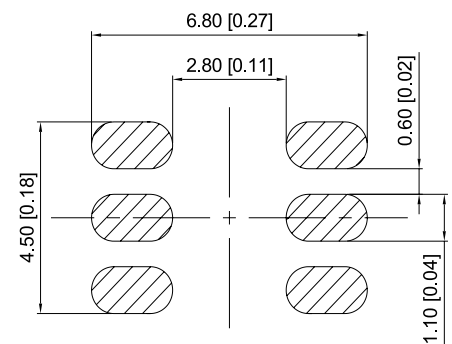

1. All dimension units are millimeters.
2. All dimension tolerance is $\pm 0.15\text{mm}$ unless otherwise noted.

Part No.	Dice	Lens Type	Luminous intensity (mcd) @ 20mA*3		Viewing Angle
			Min.	Max.	
ARL-5060URC3 Red (U4F)	RED (AlGaInP)	Water Clear	460	600	2 θ 1/2 120°

Notes

1. θ 1/2 is the angle from optical centerline where the luminous intensity is 1/2 the optical centerline value.
2. The above luminous intensity measurement allowance tolerance $\pm 10\%$.

Absolute Maximum Rating at Ta=25°C

Parameter	Rating	Units
Power dissipation	200	mW
DC Forward Current per chip	90	mA
Peak Forward Current [1]	300	mA
Reverse Voltage	5	V
Electrostatic Discharge (HBM)	2000	V
Operating Temperature	-40 ~ +85	°C
Storage Temperature	-40 ~ +100	°C

Note:

1. 1/10 Duty Cycle, 0.1ms Pulse Width.

Electrical / Optical Characteristics at Ta=25°C

Parameter	Symbol	Min.	Typ.	Max	Units	Test Conditions
Forward Voltage	VF	1.8	--	2.4	V	IF=20mA *3
Reverse Current	IR	--	--	10	uA	VR = 5V
Dominate Wavelength	λ_d	617	--	627	nm	IF=20mA *3

Typical optical characteristics curves

Ambient Temperature vs. Forward Current

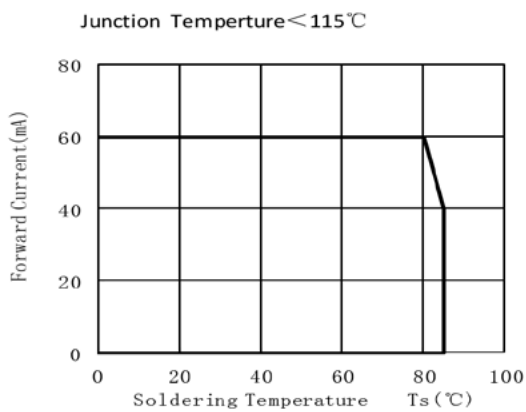

Forward Current VS. Relative Intensity

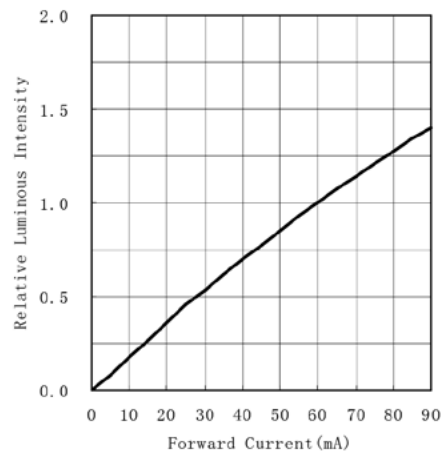

Forward Voltage VS. Forward Current

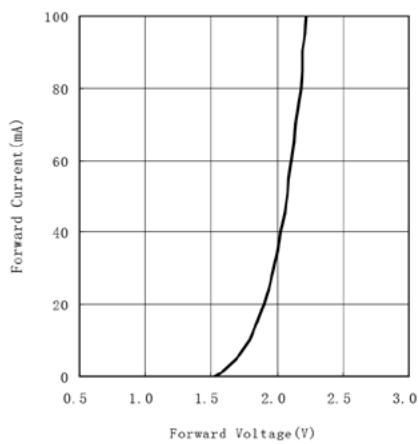

Ambient Temperature VS. Relative Intensity

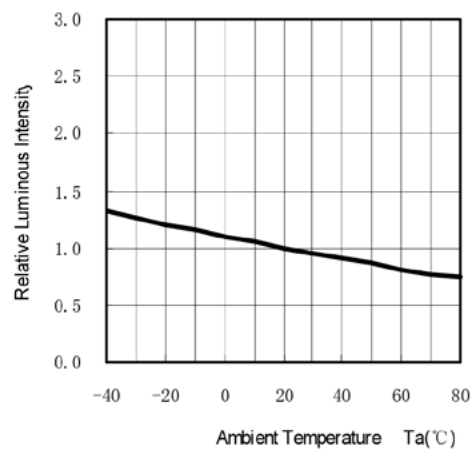

Relative spectral emission

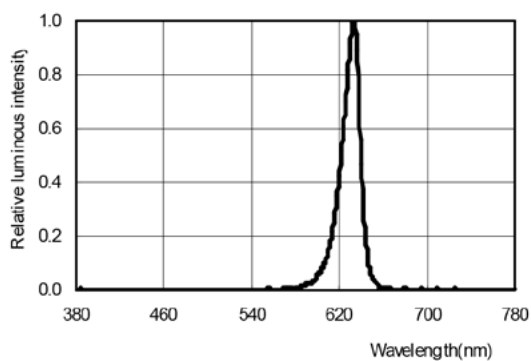

Radiation diagram

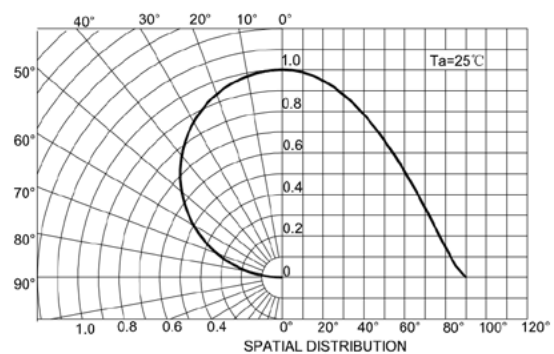

RELIABILITY TEST ITEMS AND CONDITIONS

Reliability Test Items And Conditions

Test items	Ref.Standard	Test Condition	Time	Quantity	Ac/Re
Reflow	JESD22-B106	Temp:260°C T=10 sec.	3 times.	22Pcs.	0/1
Temperature Cycle	JESD22-A104	100°C ±5°C 30 min. 5 min -40°C ±5°C 30 min.	100 Cycles	22Pcs.	0/1
High Temperature Storage	JESD22-A103	Temp.:100°C ±5°C	1000Hrs.	22Pcs.	0/1
Low Temperature Storage	JESD22-A119	Temp.: -40°C ±5°C	1000Hrs.	22Pcs.	0/1
Life Test	JESD22-A108	Ta=25°C ±5°C IF=60mA	1000Hrs.	22Pcs.	0/1
High Temperature/High Humidity Life Test	JESD22-A101	85°C±5°C/ 85%RH IF=40mA	1000Hrs.	22Pcs.	0/1

FAILURE CRITERIA

Test items	Symbol	Test Condition	Failure Criteria	
			Min	Max
Forward Voltage	VF	IF=60mA	--	U.S.L*)x1.1
Reverse Current	IR	VR = 5V	--	U.S.L*)x2.0
Luminous Flux	Im	IF=60mA	L.S.L*)x0.7	--

U.S.L: Upper Specification Lim

L.S.L: Lower Specification Limit

* The technical information shown in the data sheets are limited to the typical characteristics and circuit examples of the referenced products. It does not constitute the warranting of industrial property nor the granting of any license.

SMT REFLOW SOLDERING INSTRUCTIONS

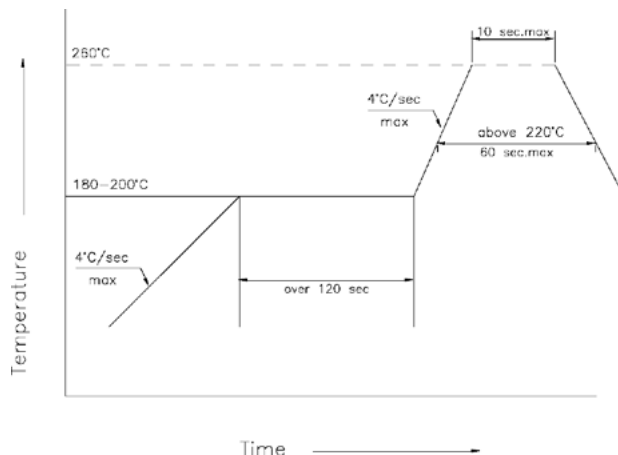

1. Reflow soldering should not be done more than two times.
2. When soldering, do not put stress on the LEDs during heating.

SOLDERING IRON

1. When hand soldering, the temperature of the iron must be less than 300°C for 3 seconds
2. The hand solder should be done only one time

REPAIRING

Repair should not be done after the LEDs have been soldered. When repairing is unavoidable, a double-head soldering iron should be used (as below figure). It should be confirmed beforehand whether the characteristics of LEDs will or will not be damaged by repairing.

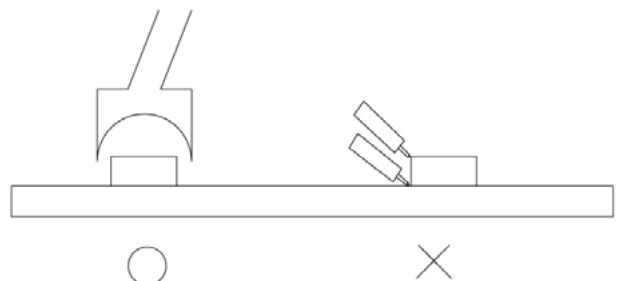

CAUTIONS

The encapsulated material of the LEDs is silicone. Therefore the LEDs have a soft surface on the top of package. The pressure to the top surface will be influence to the reliability of the LEDs. Precautions should be taken to avoid the strong pressure on the encapsulated part. So when use the picking up nozzle, the pressure on the silicone resin should be proper.

HANDLING PRECAUTIONS

Compare to epoxy encapsulant that is hard and brittle, silicone is softer and flexible. Although its characteristic significantly reduces thermal stress, it is more susceptible to damage by external mechanical force. As a result, Special handling precautions need to be observed during assemble using silicone encapsulated LED products, Failure to comply might leads to damage and premature failure of the LED.

1. Handle the component along the side surface by using forceps or appropriate tools; do not directly touch or Handle the silicone lens surface, it may damage the internal circuitry.

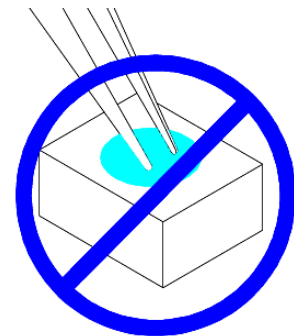
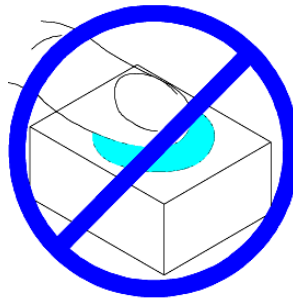
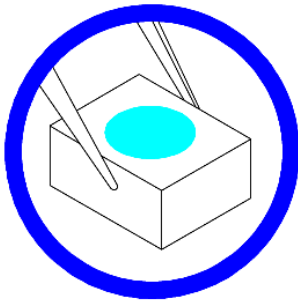

2. The outer diameter of the SMD pickup nozzle should not exceed the size of the LED to prevent air leaks. The inner diameter of the nozzle should be as large as possible. A pliable material is suggested for the nozzle tip to avoid scratching or damaging the LED surface during pickup. The dimensions of the component must be accurately programmed in the pick-and-place machine to insure precise pickup and avoid damage during production.

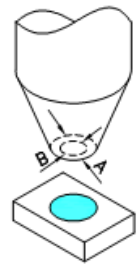

3. Do not stack together assembled PCBs containing LEDs. Impact may scratch the silicone lens or damage the internal circuitry

4. Not available in the situation of acidity for $\text{PH} < 7$



5. LED operating environment and sulfur element composition cannot be over 100PPM in the LED mating.

6. When we need to use external glue for LED application products, please make sure that the external glue matches the LED packaging glue. Additionally, as most of LED packaging glue is silica gel, and it has strong Oxygen permeability as well as strong moisture permeability; in order to prevent external material from get-ting into the inside of LED, which may cause the malfunction of LED, the single content of Bromine element is required to be less than 900PPM, the single content of Chlorine element is required to be less than 900PPM, the total content of Bromine element and Chlorine element in the external glue of the application products is required to be less than 1500PPM.

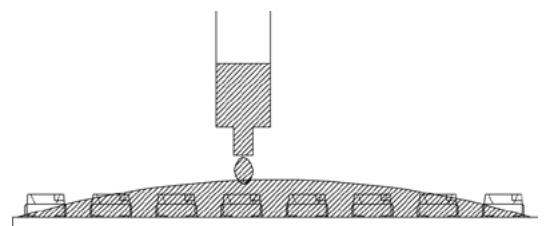

7. Other points for attention, please refer to our LED user manual.

TAPE SPECIFICATIONS (Units : mm)

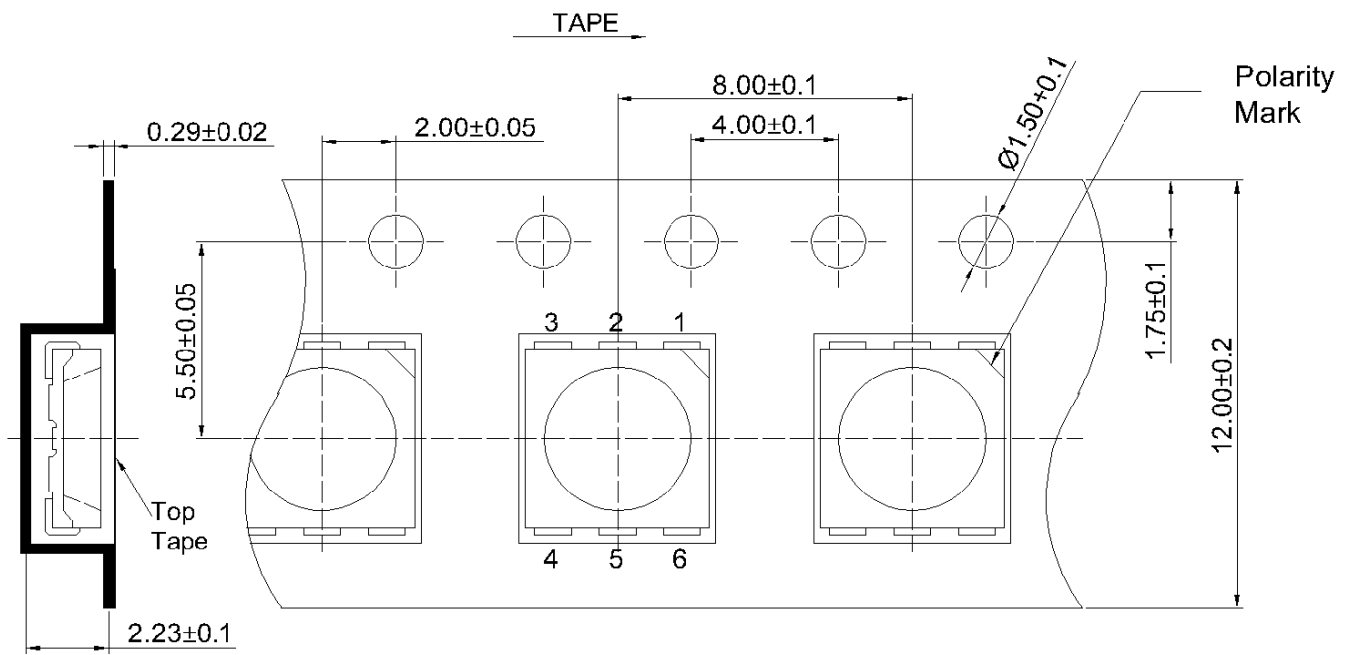

REEL DIMENSIONS

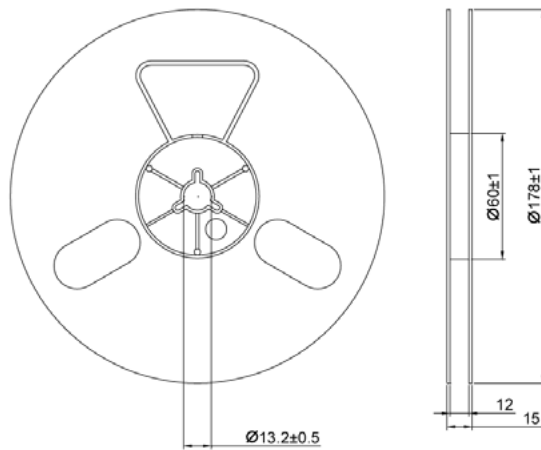

MOISTURE RESISTANT PACKAGING

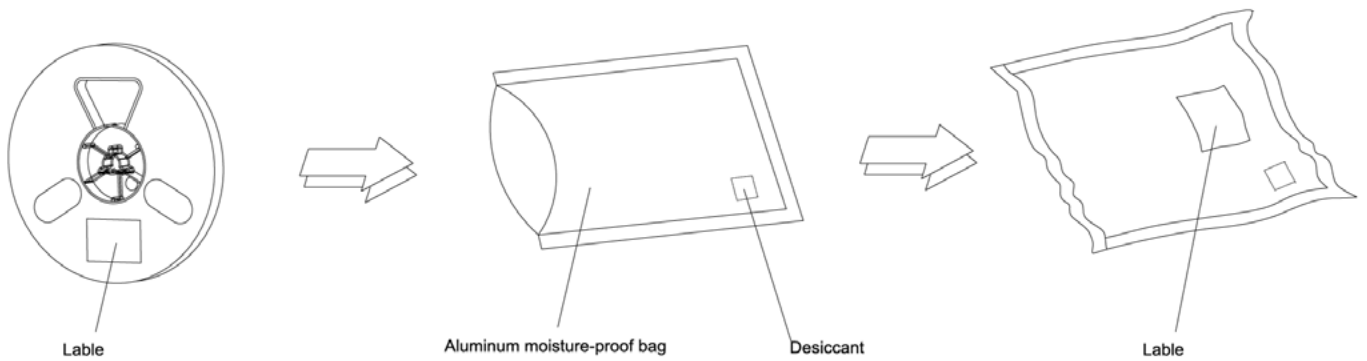

Note: The tolerances unless mentioned is $\pm 0.1\text{mm}$, Unit: mm